



User Manual

-Installation
-Operation

Omniksol-3k-TL2
Omniksol-4k-TL2
Omniksol-5k-TL2

Omnik New Energy Co., Ltd.

Catalog

1.	Notes on this manual	3
1.1	Scope of Validation	3
1.2	Symbols Used	3
1.3	Target Group	4
2.	Preparation	5
2.1	Safety Instructions.....	5
2.2	Explanations of Symbols on Inverter.....	7
3.	Product Information.....	8
3.1	Overview	8
3.2	Major Characteristics	9
3.3	Datasheet.....	10
4.	Packing checklist	12
4.1	Assembly parts.....	12
4.2	Product Appearance	13
4.3	Product Identification.....	14
4.4	Further Information.....	14
5.	Installation.....	15
5.1	Safety.....	15
5.2	Mounting Instructions	15
5.3	Safety Clearance.....	16
5.4	Mounting Procedure.....	17
5.5	Safety lock.....	20
6.	Electrical Connection	21
6.1	Safety	21
6.2	AC Side Connection.....	21
6.3	DC Side Connection.....	24
6.4	Communication and Monitoring Device.....	28
7.	Display and Operation	29
7.1	LCD Panel.....	29
7.2	Commissioning.....	30

7.3	Operation	30
7.4	State Information.....	42
8.	Recycling and Disposal.....	43
9.	Troubleshooting	44
10.	Abbreviation	46
11.	Contact	47

1. Notes on this manual

1.1 Scope of Validation

The main purpose of this User's Manual is to provide instructions and detailed procedures for installing, operating, maintaining, and troubleshooting the following three types of Omnik New Energy-Solar Inverters:

- Omniksol-3k-TL2
- Omniksol-4k-TL2
- Omniksol-5k-TL2

Please keep this user manual all time available in case of emergency.

1.2 Symbols Used



DANGER

DANGER indicates a hazardous situation which, if not avoided, will result in death or serious injury.



WARNING

WARNING indicates a hazardous situation which, if not avoided, can result in death or serious injury or moderate injury.



CAUTION

CAUTION indicates a hazardous condition which, if not avoided, can result in minor or moderate injury.



NOTICE

NOTICE indicates a situation that can result in property damage, if not avoided.

1.3 Target Group

- Chapter 1, 2, 3, 4, 7, 8, 9, 10 and chapter 11 are intended for anyone who is intended to use Omnik Grid Tie Solar Inverter. Before any further action, the operators must first read all safety regulations and be aware of the potential danger to operate high-voltage devices. Operators must also have a complete understanding of this device's features and functions.



WARNING

Do not use this product unless it has been successfully installed by qualified personnel in accordance with the instructions in Chapter 5. "Installation"

- Chapter 5 and chapter 6 are only for qualified personnel who are intended to install or uninstall the Omnik Grid Tie Solar Inverter.



NOTICE

Hereby qualified personnel means he/she has the valid license from the local authority in:

- Installing electrical equipment and PV power systems (up to 1000 V).
- Applying all applicable installation codes.
- Analyzing and reducing the hazards involved in performing electrical work.
- Selecting and using Personal Protective Equipment (PPE).

2. Preparation

2.1 Safety Instructions



DANGER

DANGER due to electrical shock and high voltage

DO NOT touch the operating component of the inverter, it might result in burning or death.

TO prevent risk of electric shock during installation and maintenance, please make sure that all AC and DC terminals are plugged out.

DO NOT stay close to the instruments while there is severe weather conditions including storm, lighting etc.



WARNING

The installation, service, recycling and disposal of the inverters must be performed by qualified personnel only in compliance with national and local standards and regulations. Please contact your dealer to get the information of authorized repair facility for any maintenance or repairmen. Any unauthorized actions including modification of product functionality of any form will affect the validation of warranty service; Omnik may deny the obligation of warranty service accordingly.



NOTICE

Public utility only

The PV inverter designed to feed AC power directly into the public utility power grid; do not connect AC output of the device to any private AC equipment.



CAUTION

The PV inverter will become hot during operation; please don't touch the heat sink or peripheral surface during or shortly after operation.

Risk of damage due to improper modifications. Never modify or manipulate the inverter or other components of the system.

2.2 Explanations of Symbols on Inverter

Symbol	Description
	<p>Dangerous electrical voltage This device is directly connected to public grid, thus all work to the inverter shall only be carried out by qualified personnel.</p>
	<p>DANGER to life due to high electrical voltage! There might be residual currents in inverter because of large capacitors. Wait 10 MINUTES before you remove the front lid.</p>
	<p>NOTICE, danger! This device directly connected with electricity generators and public grid.</p>
	<p>Danger of hot surface The components inside the inverter will release a log of heat during operation, DO NOT touch aluminum housing during operating.</p>
	<p>An error has occurred Please go to Part 10 “Trouble Shooting” to remedy the error.</p>
	<p>This device SHALL NOT be disposed of in residential waste Please go to Part 9 “Recycling and Disposal” for proper treatments.</p>
	<p>Without Transformer This inverter does not use transformer for the isolation function.</p>
	<p>Standards Association of Australian The inverter complies with the requirement of the AS4777.</p>
	<p>CE Mark Equipment with the CE mark fulfils the basic requirements of the Guideline Governing Low-Voltage and Electromagnetic Compatibility.</p>
	<p>No unauthorized perforations or modifications Any unauthorized perforations or modifications are strictly forbidden, if any defect or damage (device/person) is occurred, Omnik shall not take any responsibility for it.</p>

3. Product Information

3.1 Overview

- Industrial Layout



- Excellent Heat Elimination

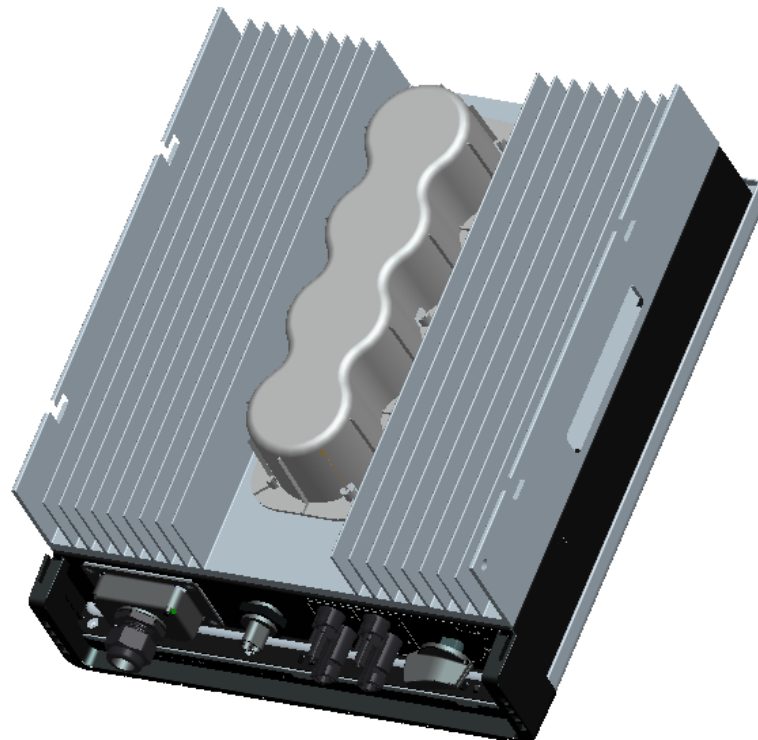

- Effective Shield For DC/AC/Communication Connections



3.2 Major Characteristics

Omnik inverter has following characteristics which make Omnik inverter “High Efficiency, High Reliability, High Cost Effective Ratio”

- Wide DC input voltage and current range, enables more PV panels connected.
- Wide MPP voltage range ensure high yield under various weather conditions.
- High MPP tracking accuracy, ensure the minimum power loses during converting.
- Complete set of protection methods.

Also, following protection methods are integrated in Omnik inverter:

- Internal overvoltage
- DC insulation monitoring
- Ground fault protection
- Grid monitoring
- Ground fault current monitoring
- DC current monitoring
- Integrated DC switch (Optional)

3.3 Datasheet

Type	Omniksol-3k-TL2	Omniksol-4k-TL2	Omniksol-5k-TL2
Input (DC)			
Max. PV Power	3400W	4500W	5000W
Max DC Voltage	590V	590V	590V
Nominal DC Voltage	360V	360V	360V
Operating MPPT Voltage Range	120 - 550V	120 - 550V	120 - 550V
MPPT Voltage Range at Nominal Power	150 - 500V	200 - 500V	200 - 500V
Start up DC Voltage	150V	150V	150V
Turn off DC Voltage	120V	120V	120V
Max. DC Current	12A/12A	16A/16A	18A/18A
Max. Short Circuit Current for each MPPT	16A/16A	20A/20A	20A/20A
Number of MPP trackers	2	2	2
Max. Input Power for each MPPT	2000W	2600W	3000W
Number of DC Connection for each MPPT	1/1	1/1	1/1
DC Connection Type	MC4 connector	MC4 connector	MC4 connector
Output (AC)			
Max. AC Apparent Power	3300VA	4400VA	5000VA*
Nominal AC Power(cos phi = 1)	3000W	4000W	5000W**
Nominal Grid Voltage	220V/230V/240V	220V/230V/240V	220V/230V/240V
Nominal Grid Frequency	50Hz/60Hz	50Hz/60Hz	50Hz/60Hz
Max. AC Current	14.4A	19.0A	22.0A
Grid Voltage Range*	185-276V	185-276V	185-276V
Grid Frequency Range*	45-55Hz/55-65Hz	45-55Hz/55-65Hz	45-55Hz/55-65Hz
Power Factor	0.95 capacitive...0.95 inductive	0.95 capacitive...0.95 inductive	0.95 capacitive...0.95 inductive
Total Harmonic Distortion (THD)	<2%	<2%	<2%
Feed in Starting Power	30W	30W	30W
Night time Power Consumption	<1W	<1W	<1W
Standby Consumption	6W	6W	6W
AC Connection Type	Plug-in connector	Plug-in connector	Plug-in connector
Efficiency			
Max. Efficiency (at 360Vdc)	98.2%	98.2%	98.2%
Euro Efficiency (at 360Vdc)	97.3%	97.5%	97.5%
MPPT Efficiency	99.9%	99.9%	99.9%
Safety and Protection			
DC Insulation Monitoring	Yes		
DC Switch	Optional		
Residual Current Monitoring Unit (RCMU)	Integrated		
Grid Monitoring with Anti-islanding	Yes		
Protection Class	I (According to IEC 62103)		
Overvoltage Category	PV II / Mains III (According to IEC 62109-1)		

Type	Omnisol-3k-TL2	Omnisol-4k-TL2	Omnisol-5k-TL2
Reference Standard			
Safety Standard	EN 62109, AS/NZS 3100		
EMC Standard	EN 61000-6-1, EN 61000-6-3, EN 61000-6-2, EN 61000-6-4, EN61000-3-2, EN61000-3-3, EN61000-3-11, EN61000-3-12		
Grid Standard	VDE-AR-N-4105, VDE 0126-1-1, RD1699, CEI0-21, C10/11, G83/2, UTE C15-712-1, AS4777, CQC		
Physical Structure			
Dimensions (WxHxD)	352x421x162.5mm		
Weight	16.5kg		
Environmental Protection Rating	IP 65 (According to IEC 60529)		
Cooling Concept	Internal fan convection		
Mounting Information	Wall bracket		
General Data			
Operating Temperature Range	-20°C to +60°C(derating above 45°C)		
Relative Humidity	0% to 98%, no condensation		
Max. Altitude (above sea level)	2000m		
Noise Level	< 40dB		
Isolation Type	Transformerless		
Display	3 LED, Backlight,20 x 4 Character LCD		
Data Communication Interfaces	RS485(WiFi, GPRS, intergrated)		
Computer Communication	USB		
Standard Warranty	10 Years (15 years optional)		

*The AC voltage and frequency range may vary depending on specific country grid

**4600VA, 4600W with VDE-AR-N-4105

4. Packing checklist

4.1 Assembly parts

After you receive the Omnik inverter, please check if there is any damage on the carton, and then check the inside completeness for any visible external damage on the inverter or any accessories. Contact your dealer if anything is damaged or missing.



A



B



C



D

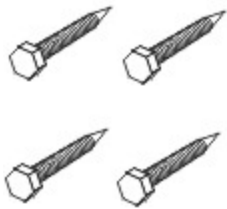

E

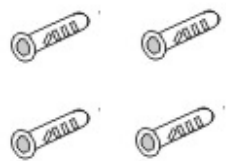

F

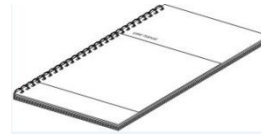

G

Object	Quantity	Description
A	1	Omnik inverter
B	2 pairs	DC connector
C	1	AC connector
D	1	Wall mounting bracket
E	4	Screw (ST6x50)
F	4	Expansion tube
G	1	Installation and operating instructions

4.2 Product Appearance

- Front

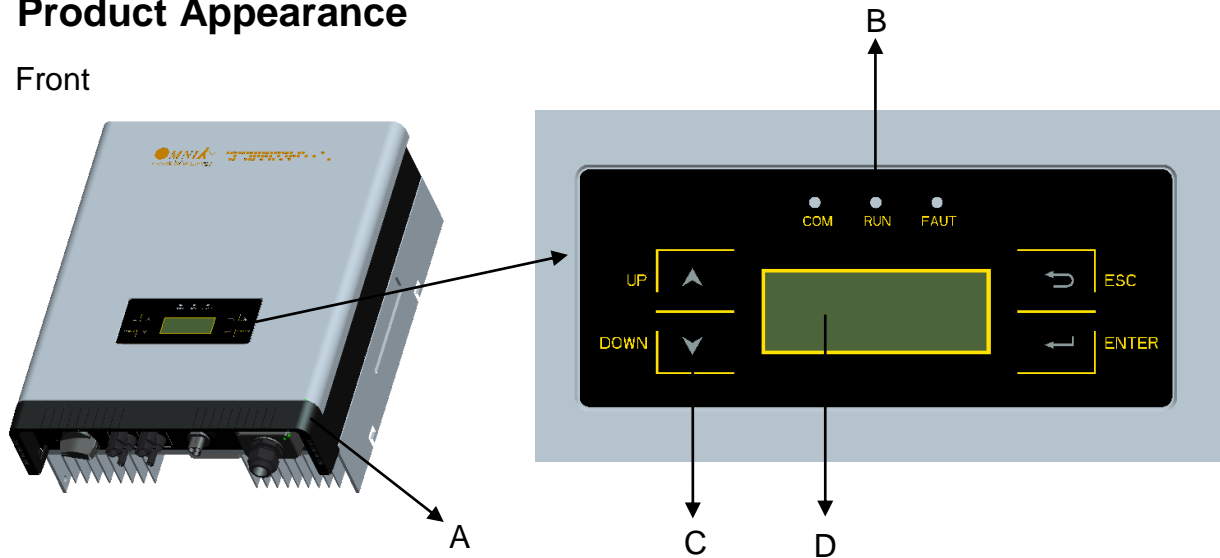

Object	Description
A	Removable front shield
B	LED light (3 pcs)
C	Function keys for displays and choice of language(4 pcs)
D	Monitoring LCD with backlighting

- Bottom

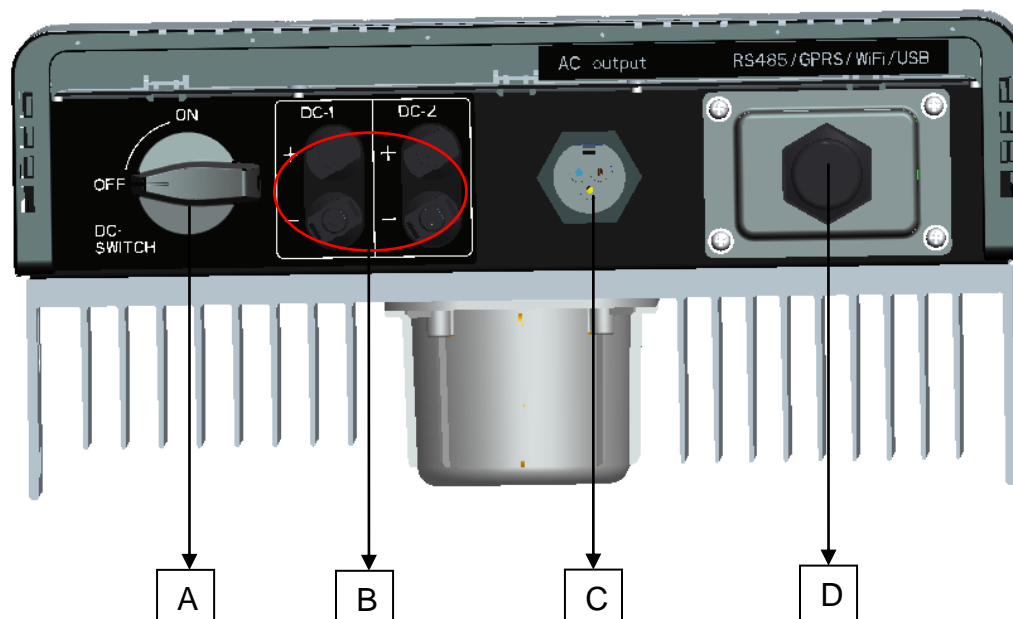

Object	Description
A	DC switch (optional)
B	Plug connectors for DC input
C	Terminal for grid connection (AC output)
D	Communication interface(RS485/GPRS/WiFi/USB)

4.3 Product Identification

You can identify the inverter by the side name plate. Information such as type of the inverter, as well as inverter specifications are specified on the side name plate. The name plate is on the middle part of the right side of the inverter housing. And the following figure is the side name plate example as on **Omniksol-5k-TL2**.

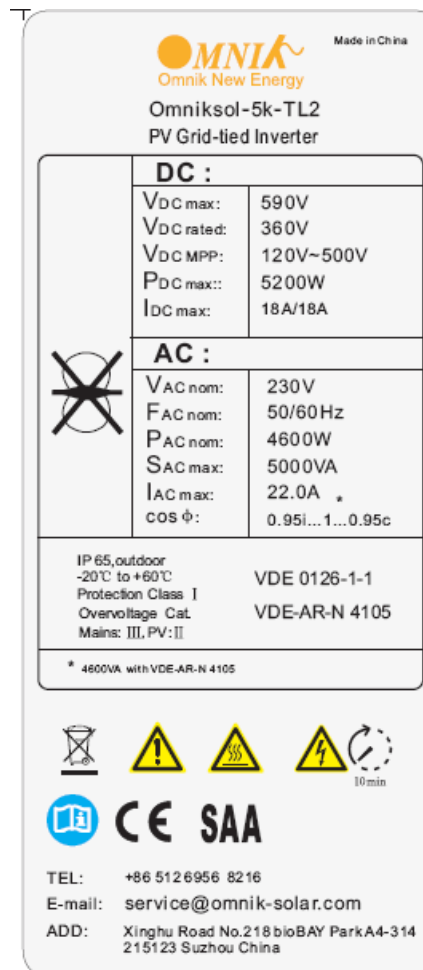

4.4 Further Information

If you have any further questions concerning the type of accessories or installation, please check our website www.omnik-solar.com or contact our service hotline.

5. Installation

5.1 Safety



DANGER

DANGER to life due to potential fire or electricity shock.

DO NOT install the inverter near any inflammable or explosive items.

This inverter will be directly connected with **HIGH VOLTAGE** power generation device; the installation must be performed by qualified personnel only in compliance with national and local standards and regulations.



NOTICE

NOTICE due to the inappropriate or the harmonized installation environment may jeopardize the life span of the inverter.

Installation directly expose under intensive sunshine is not recommended.

The installation site **MUST** have good ventilation condition.

5.2 Mounting Instructions

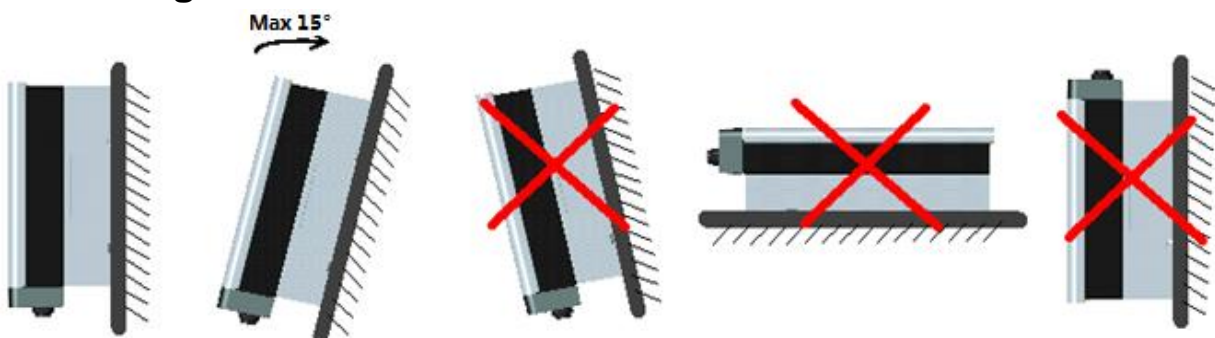

- Omnik inverter is designed for indoors and outdoors installation
- Please mount the inverter in the direction as illustrated above

- Install the inverter in the vertical direction is recommended, with a max.15 degrees backwards.
- For the convenience of checking the LCD display and possible maintenance activities, please install the inverter at eye level.
- Make sure the wall you selected is strong enough to handle the screws and bear the weight of the inverter
- Ensure the device is properly fixed to the wall
- It is not recommended that the inverter is exposed to the strong sunshine, because the excess heating might lead to power reduction
- The ambient temperature of installation site should be between -20 °C and +60 °C (between -4 °F and 140 °F)
- Make sure the ventilation of the installation spot, not sufficient ventilation may reduce the performance of the electronic components inside the inverter and shorten the life of the inverter

5.3 Safety Clearance

Observe the following minimum clearances to walls, other devices or objects to guarantee sufficient heat dissipation and enough space for pulling the electronic solar switch handle.

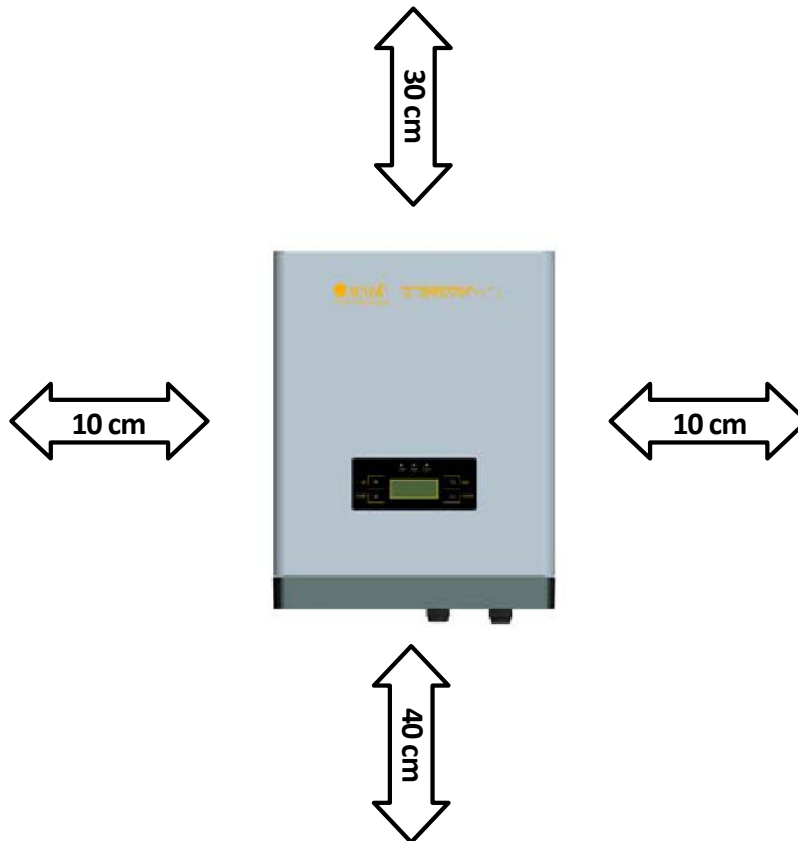

Direction	Minimum clearance
Above	30 cm
Below	40 cm
Sides	10 cm

5.4 Mounting Procedure

1. Mark 4 positions of the drill holes on the wall according to the wall mounting bracket in the carton box.

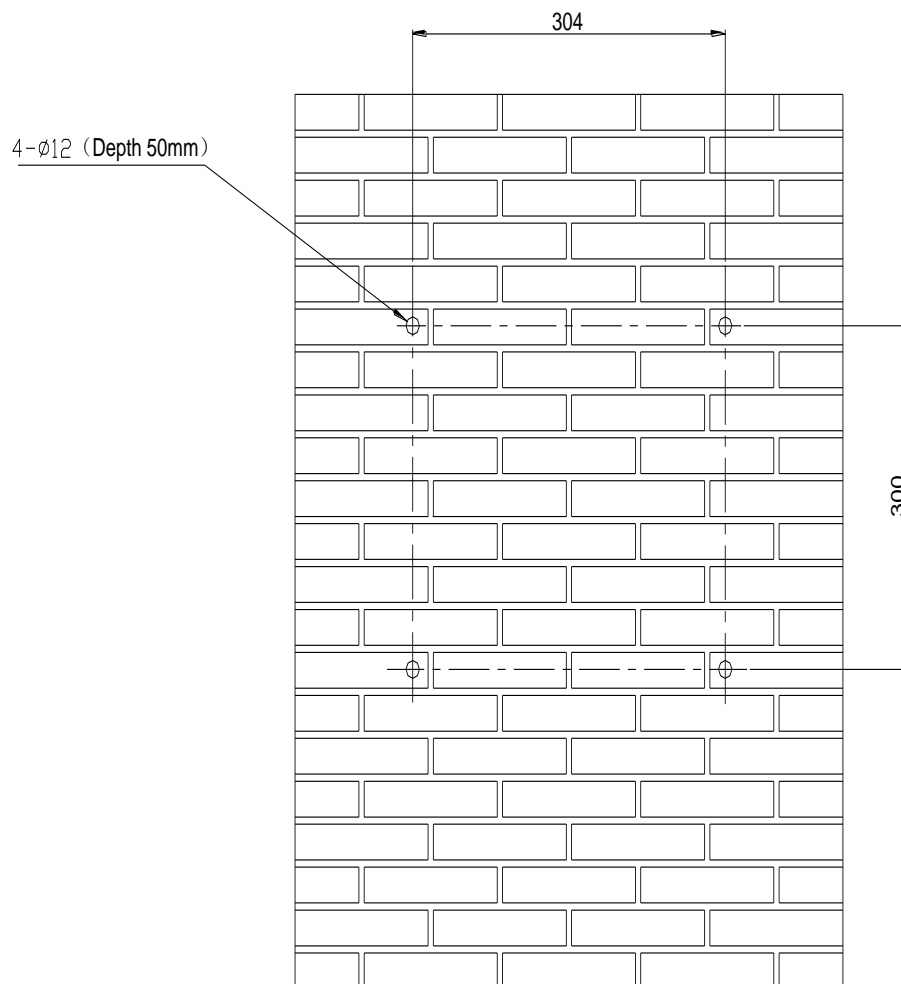

2. According to the marks, drill 4 holes in the wall. Then place four expansion tubes in the holes using a rubber hammer. Next make 4 screws through the mounting holes in the bracket, and then tighten the screws into the expansion tubes. So far, the wall mounting bracket is fixed already.

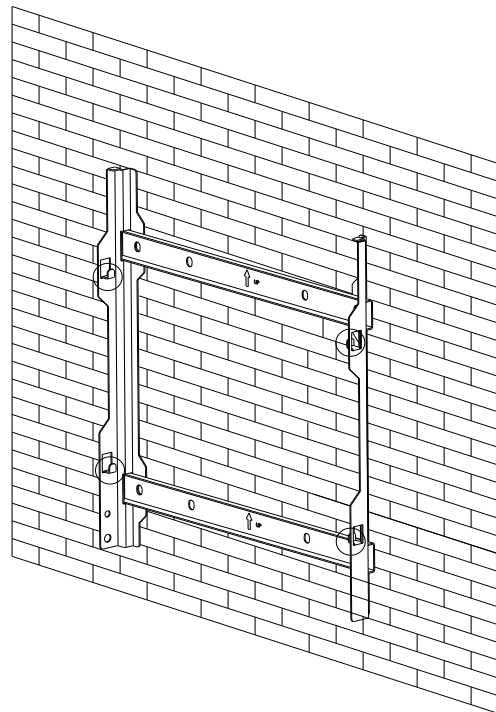
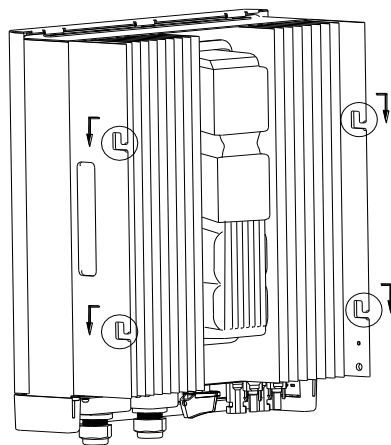
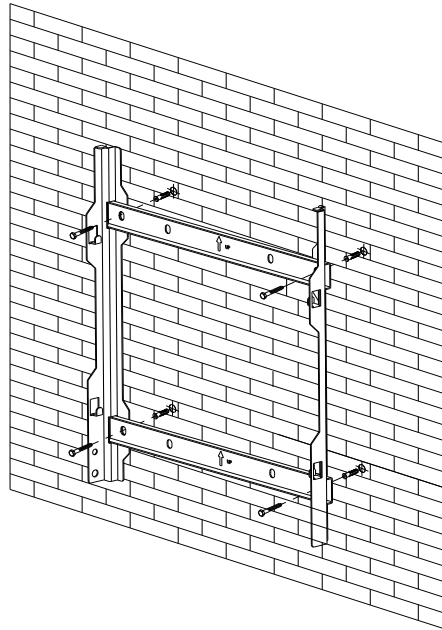

3. Check the 4 holes in the backside of the inverter. Then lift the inverter carefully, align the 4 holes in the inverter and the 4 hooks on the bracket, and finally attach the inverter to the hooks slightly.

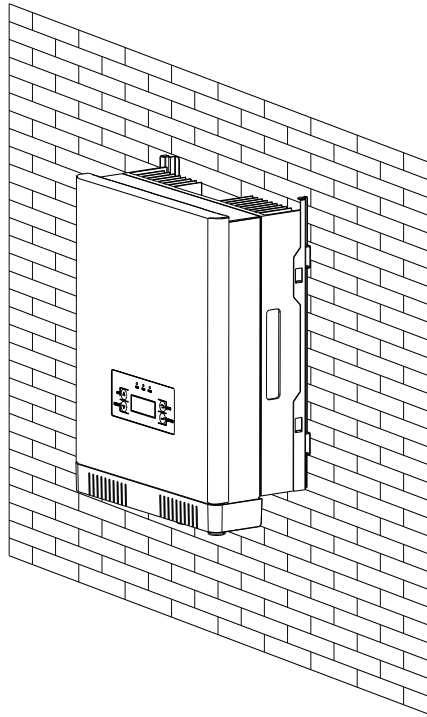

5.5 Safety lock

After the inverter is hanging up on the bracket, lock up the device and the bracket together at the Lower Left Corner of the inverter (as the picture showed below).

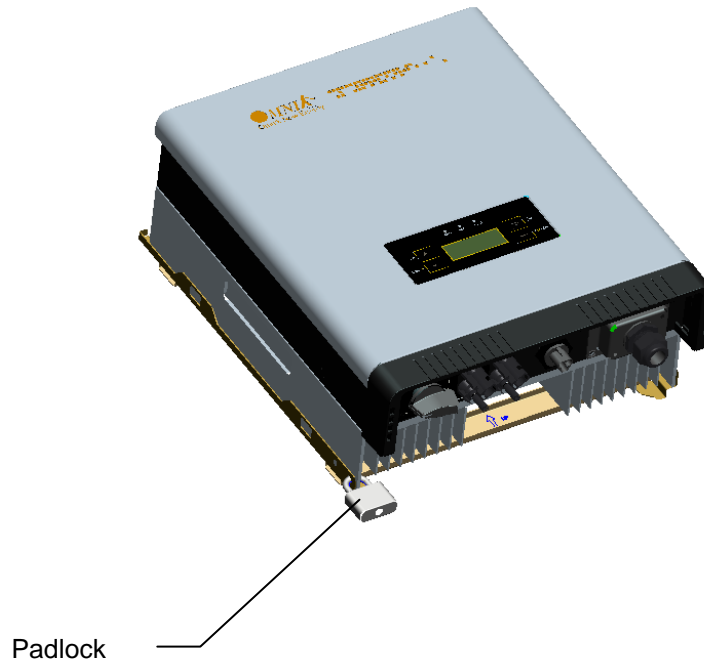

Recommended padlock dimension:

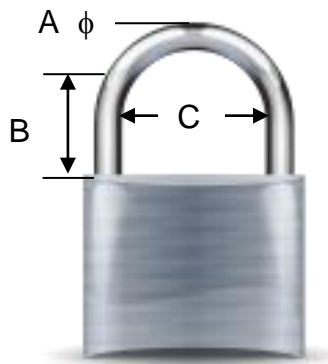

A. Shackle Diameter	5~7 mm
B. Vertical Clearance	8~15 mm
C. Horizontal Clearance	12~20 mm
Stainless, solid hanger and secured lock cylinder	



NOTICE

For further maintenance and possible repair, please keep the key of the padlock in a safe place.

6. Electrical Connection

6.1 Safety



DANGER

DANGER to life due to potential fire or electricity shock.

With the inverter powered, comply with all prevailing national regulations on accidents prevention.

This inverter will be directly connected with **HIGH VOLTAGE** power generation device; the installation must be performed by qualified personnel only in compliance with national and local standards and regulations.



NOTICE

Electrical connections shall be carried out in accordance with the applicable regulations, such as conductor sections, fuses, PE connection.

6.2 AC Side Connection



DANGER

DANGER to life due to potential fire or electricity shock.

NEVER connect or disconnect the connectors under load.

1. Integrated RCD and RCM

The Omniksol inverter is equipped with integrated RCD (Residual Current Protective Device) and RCM (Residual Current Operated Monitor). The current sensor will detect the volume of the leakage current and compare it with the pre-set value, if the leakage current exceeds the permitted range, the RCD will disconnect the inverter from the AC load.

2. Assembly Instructions



NOTICE

Use **14-12AWG (2-4mm²)** copper wire for all AC wiring connections to Omnik inverter. Use only solid wire or stranded wire.

- 1) Remove length y of **N,L** conductor 35mm(1.38")/**PE** conductor 40mm(1.57") sheath of AC cable terminal, length x about 14mm(0.55") of the inner wrapper, then dress the conductor terminals with ferrules or tin soldering.

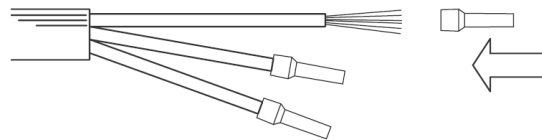
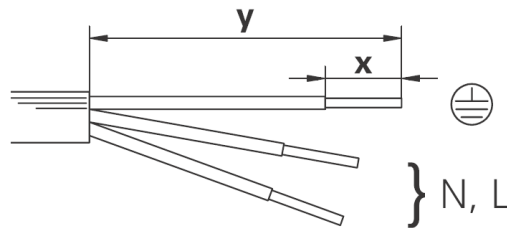

- 2) Check that all parts of AC connector are present. Then slide hex nut onto the cable and insert the cable end through clamp ring.

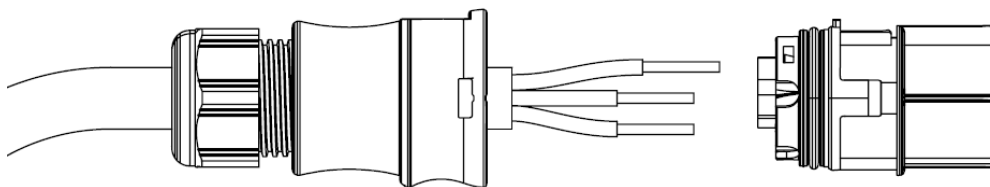

- 3) Insert the **stripped N, L and PE conductor terminal** to the appointed holes, use a cross screwdriver to tighten it with tightening torque 1Nm.

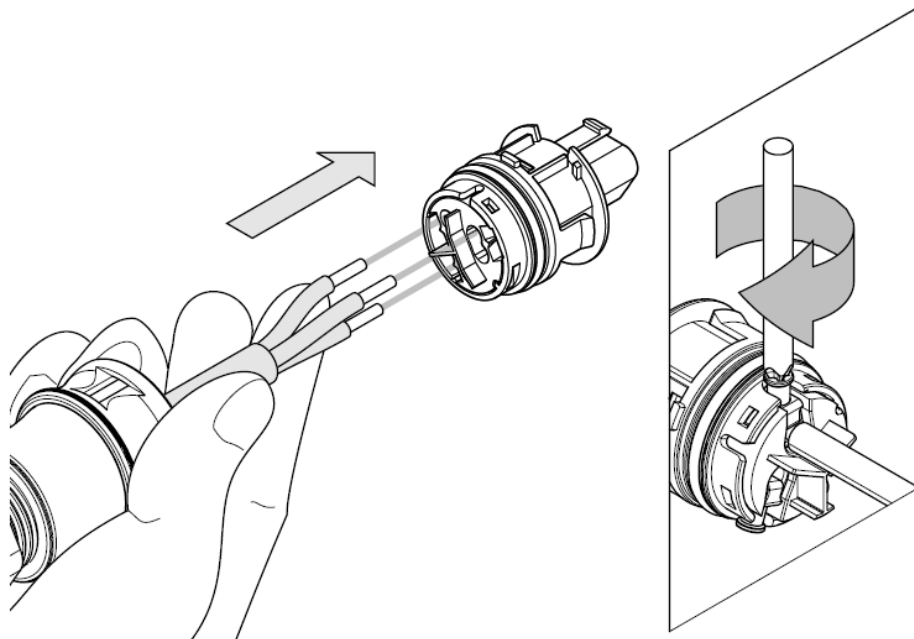

- 4) Insert the connector to clamp ring with two click sound and then tighten the hex nut with tightening torque 4Nm.

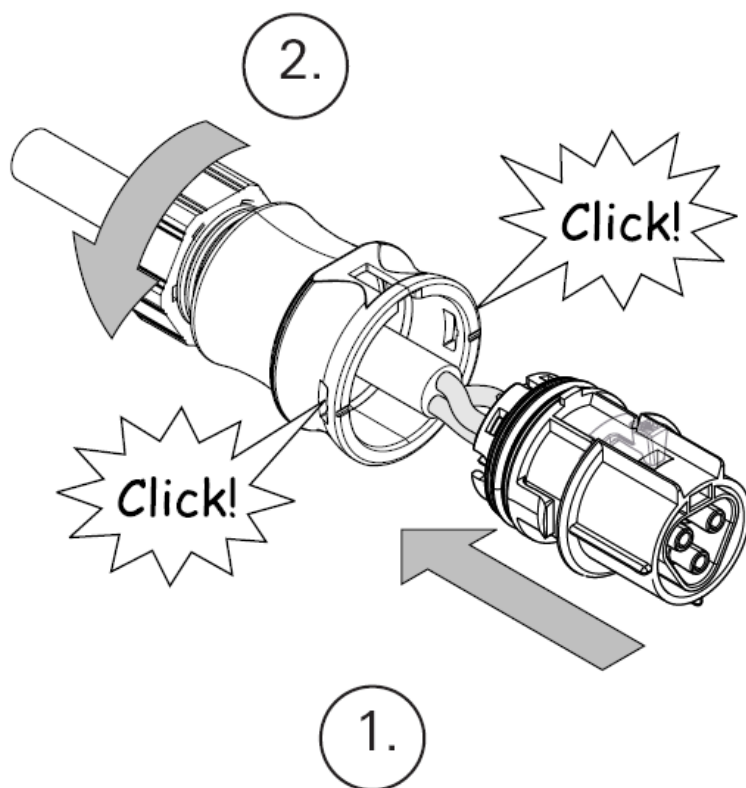

- 5) Finally connect the straight plug to the AC terminal on inverter. **Pay attention to the polarity of the terminals to avoid wrong connecting.**

6.3 DC Side Connection



DANGER

DANGER to life due to potential fire or electricity shock.
NEVER connect or disconnect the connectors under load.



NOTICE

DC Switch (**Optional**) may be integrated or external to Inverter, and it can be used to connect or disconnect the DC source from Inverter.

For Omniksol-3k-TL2, Omniksol-4k-TL2 and Omniksol-5k-TL2, there are two MPP Trackers, and the DC characteristics of them are illustrated as the following table.

Inverter Type	MPP Tracker	Max. DC Power	Max. DC Voltage	Max. DC Current
Omniksol-3k-TL2	2	3400W	590V	12*2A
Omniksol-4k-TL2		4600W		16*2A
Omniksol-5k-TL2		5200W		18*2A

MC4 Assembly instructions

 If, during self assembly, parts and tools other than those stated by MC are used or if the preparation and assembly instructions described here are disregarded then neither safety nor compliance with the technical data can be guaranteed.

 For protection against electric shock, PV-connectors must be isolated from the power supply while being assembled or disassembled.

 The end product must provide protection from electric shock.

 The use of PVC cables is not recommended.

 Unplugging under load: PV plug connections must not be unplugged while under load. They can be placed in a no load state by switching off the DC/AC converter or breaking the DC circuit interrupter. Plugging and unplugging while under voltage is permitted.

 It is inadvisable to use non-tinned cables of type H07RN-F, since with oxidized copper wires the contact resistances of the crimp connection may exceed the permitted limits.

 Disconnected connectors should be protected from dirt and water with sealing caps.

 Plugged parts are watertight IP67. They cannot be used permanently under water. Do not lay the MC-PV connectors on the roof surface.

 See the MC catalogue 2 solar lines for technical data and assembled parts.

PV-Female cable coupler



PV-KBT4

PV-Male cable coupler



PV-KST4

Optional



PV-SSH4

Touch protection, mated/unmated	IP67/IP2X	Rated current	17A(1,5mm ² /16AWG) 22A(2,5mm ² /14AWG) 30A(4mm ² ,6mm ² /10AWG)
Ambient temperature range	-40° to 90°C (IEC/CEI) -40° to 75°C(UL) -40° ...70°C (UL:14AWG)	Rated voltage	1000V (IEC/CEI) 600V (UL)
Upper limiting temperature	105°C (IEC/CEI)	Safety class	II

Note: The DC connector is MC4 type; you can order the specified tools at MC website: <http://www.multi-contact.com>.

Tools required

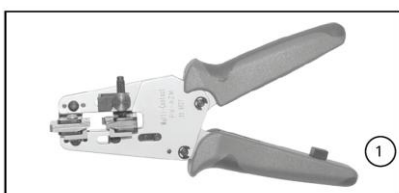

(ill. 1)
Stripping pliers PV-AZM... incl. built-in blade as well as hexagonal screwdriver A/F 2,5mm.

Cable cross section: 1,5 / 2,5 / 4 / 6 mm²

Type: PV-AZM-1.5/6

Order No. 32.6029-156

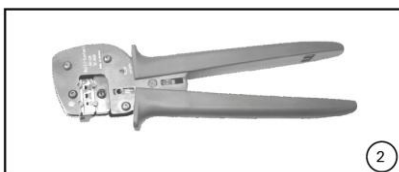

(ill. 2)
Crimping pliers PV-CZM... incl. locator and built-in crimping insert.

Crimping range: 2,5 / 4 / 6 mm² (12 / 10 AWG)

Type: PV-CZM-19100

Order No. 32.6020-19100



(ill. 3)
Open-end spanner PV-MS,
1 Set = 2 pieces
Order No.: 32.6024



(ill. 4)
PV-WZ-AD/GWD socket wrench insert to tighten
Order No. 32.6006

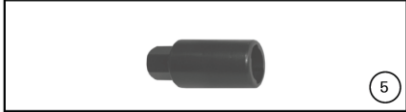

(ill. 5)
PV-SSE-AD4 socket wrench insert to secure
Order No. 32.6026



(ill. 6)
Test plug PV-PST
Order No. 32.6028

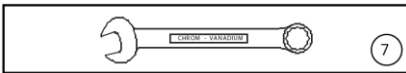

(ill. 7)
Open-end spanner A/F 15 mm



(ill. 8)
Torque screwdriver A/F 12 mm

Cable preparation

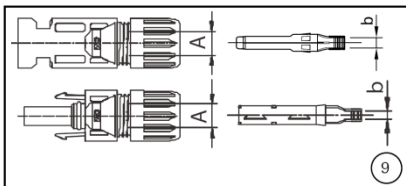

(ill. 9)
Use 14-10AWG (2.5-6mm²) conductor as DC cable.
Dimension **A** 3-6mm, **b** 2.5-6mm²

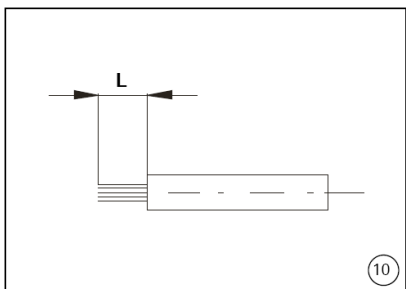

(ill. 10)
Strip the cable end **L** with 6 mm to 7.5 mm of insulation.

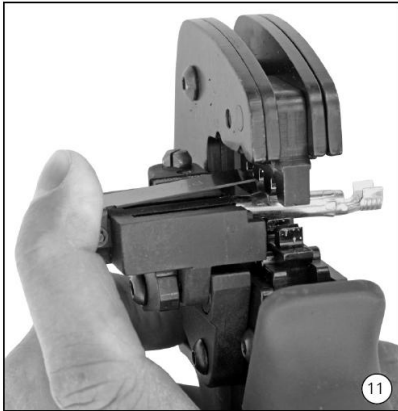

(ill. 11)
Open the clamp (K) and hold. Place the contact in the appropriate cross section range.
Turn the crimp lugs upwards. Release the clamp (K). The contact is fixed.

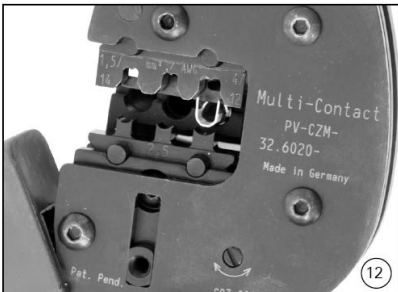

(ill. 12)
Press the pliers gently together until the crimp lugs are properly located within the crimping die.

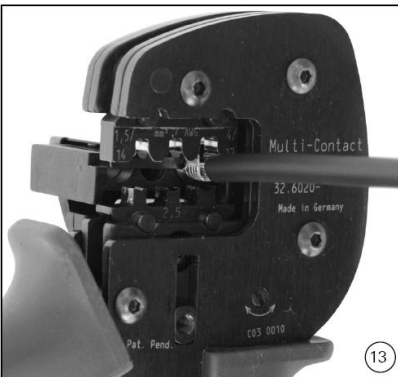

(ill. 13)
Insert the stripped cable end until the insulation comes up against the crimp insert. Completely close the crimping pliers.



(ill. 14)
Visually check the crimp.



(ill. 15)
Insert the crimped-on contact into the insulator of the male or female coupler until it clicks into place. Pull gently on the lead to check that the metal part is correctly engaged.



(ill. 16)
Insert the appropriate end of the test pin into the male or female coupler as far as it will go. If the contact is correctly located, the white mark on the test pin must still be visible.

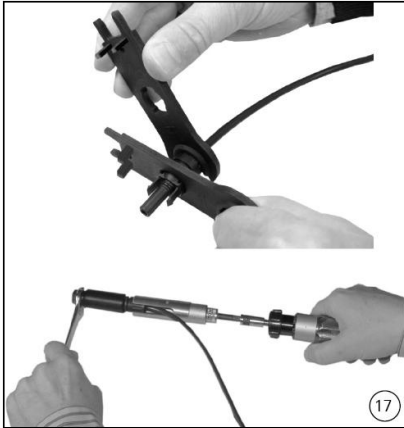

(ill. 17)

Screw up the cable gland hand-tight with the tools PV-MS or tighten the cable gland with the tools PV-WZ-AD/GWD and PV-SSE-AD4.

In both cases: The tightening torque must be appropriate for the solar cables used. Typical values are between 2,5 Nm and 3 Nm.

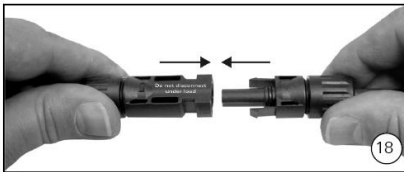

(ill. 18)

Plug the parts of the cable coupler together until they click in place. Check that they have engaged properly by pulling on the cable coupler.

6.4 Communication and Monitoring Device

There are 2 RJ45 plugs in the bottom side of the Omnik inverter as the following figure:

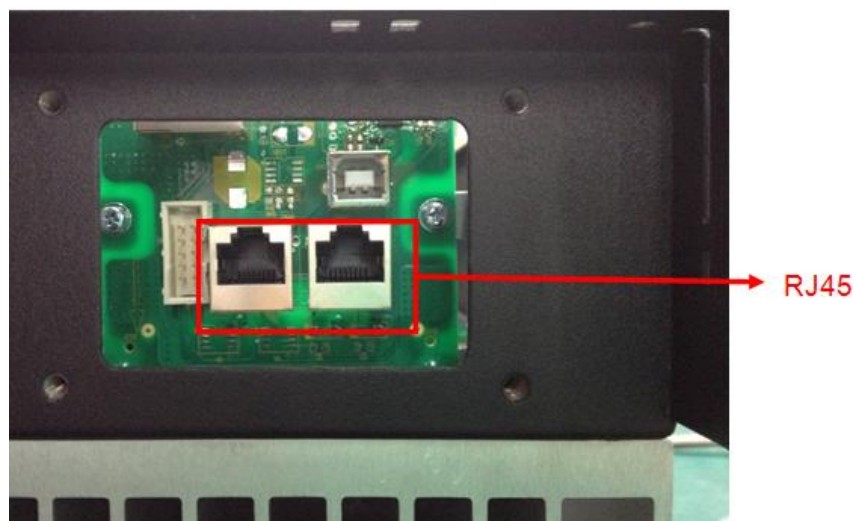

These 2 RJ45 plugs are used for multipoint communications, that is, up to 50 Omnik inverters can be connected one by one through these 2 plugs and the cables, the upper computer can communicate with these inverters via a single signal cable at the same time, and maximum length of the cable is 1000m. Through these plugs, the user can get the data from these inverters, and can also configure parameters of them.

7. Display and Operation

7.1 LCD Panel

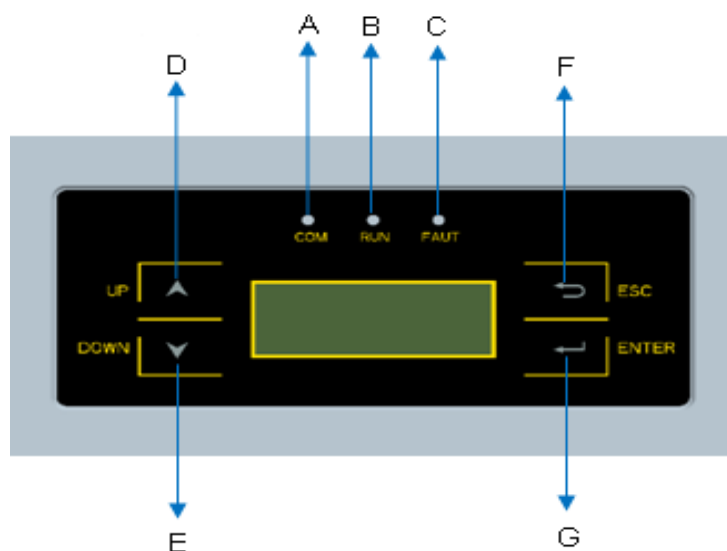

Object	Description
A	LED light(Yellow) – COM
B	LED light(Green) – RUN
C	LED light(Red) – FAULT
D	UP key
E	DOWN key
F	ESC key
G	ENTER key

The LCD panel is integrated in the front lid of the inverter, so it is easy for user to check and set the data. In addition, the user can press the function key to illuminate the LCD screen.



NOTICE

Omnik inverter is not an aligned measuring instrument for current, voltage or power consumption. A slight deviation of a few percent points is intrinsic to the system; the results from the inverter cannot be used for grid balance calculations. An aligned meter will be required to make calculations for the utility company.

7.2 Commissioning



NOTICE

The power supply of display module is AC grid, so the screen will not be available until AC is connected.

A minimum available voltage of 150Vdc and a DC power of >10Wdc is required before the inverter starts feeding power to the grid.

AC side: Turn on the AC circuit break and the display module will work.

DC side: Turn on the DC switch.

When the inverter is started for the first time, a menu is displayed to choose language and the country where the inverter installed, English, Dutch and Deutsch are available for display.



NOTICE

You need to confirm that you choose the right country safety to ensure that compliance with local standards.

7.3 Operation

7.3.1 System operation interface

System operation interface 1:

```
Waiting      0      Italy
Power        0W
EToday       0.00kWh
Info         Error   Set
```



In this interface, the displayed “**Waiting 0**” part will switch along with the system operation status.

The system will have the following status:

1. Waiting status: Display as Waiting XXX, XXX refers to the countdown time, will display 1~3 numbers.
2. Flash status: Display as Flash
3. Fault status: Display as Fault XX, XX refers to error code, will display 1~2 numbers.

Power and **EToday** in this interface will change along with the change of number after system operation.

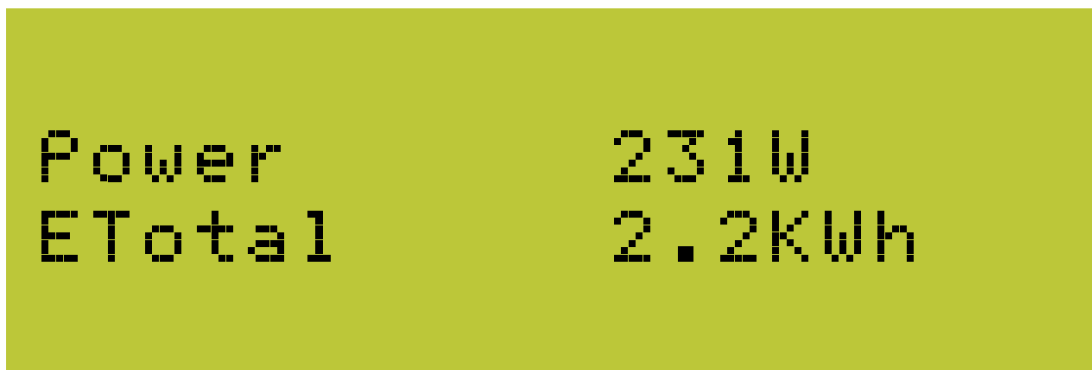
System operation interface 2:



Power and **ETotal** in this interface will change along with the change of number after system operation.

System operation interface 3:

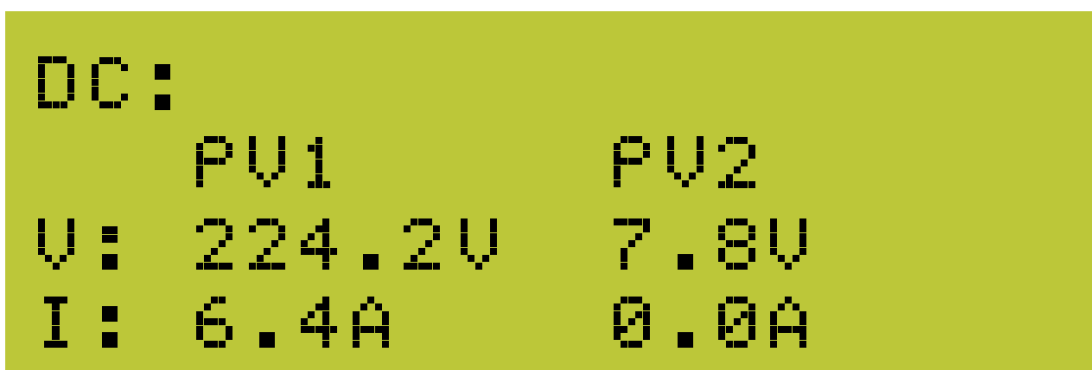

This interface displays the input voltage and current of the 2 input PV panel.

System operation interface 4:

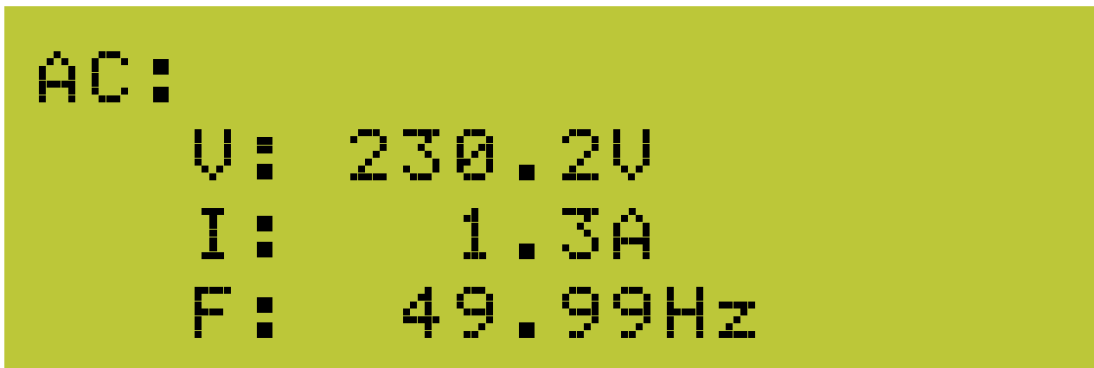

This interface displays the voltage and frequency of grid and the current which inverter outputs to the grid.

System operation interface 5:



This interface displays the WiFi information of the inverter, including WiFi SN and IP address.

7.3.2 Interface introduction

Safety Interface: When choose “**Safety**” by pressing compound key (**ESC+ENTER**) in system operation interface 1 for 3 seconds.

```

Waiting      0      Italy
Power        0W
EToday       0.00kWh
Info         Error   Set
  
```

Safety “Italy” in the screen flickers. After confirm to enter, password dialog box appears. The default password is “654321”.

```

Password
      000000
  
```

After entering the password, system will get to the safety selection interface.

Safety selection interface:

```

Safety      Spain
            VDE-0126
            VDE-4105
            Italy
  
```

The selected safety information flickers. The selectable safety information as following:

Italy	VDE-4105	VDE-0126	Spain	GREMAIN
Portugal	Belgium	Italy _ S	EnglG83	EnglG59
Austral	China	GerBDEW	Dan mark	Grelsla
Czech	Slovak	Holland	Sweden	Bulgaria
France	Brazil	EngG592	Holl16A	SAfrica

These safety information will be arranged in 4 lines, i.e. there will be 4 safety information displayed in the same interface.

Info Interface:

You can choose “Info” by **UP** and **DOWN** key in system operation interface 1

```
Waiting      0      Italy
Power        0W
EToday       0.00kWh
Info         Error   Set
```

While “Info” flickers. Confirm to enter Info mode. There will be 7 interfaces in the Info mode.

1. PV panel information:

```
DC:
      PV1      PV2
U:  224.2V    7.8V
I:  6.4A      0.0A
```

2. AC grid information:

```
AC:
      U:  230.2V
      I:   1.3A
      F:  49.99Hz
```

3. Inverter's Model information:

```
Model :  
5000TL2
```

4. Inverter's SN Information:

```
SN :  
DEDN50201306T527
```

5. Inverter's master CPU information:

```
Master CPU :  
V98 Build00
```

6. Inverter's slave CPU information:

```
Slave CPU :  
V0.0.0Build00
```

7. Inverter's display module version information:

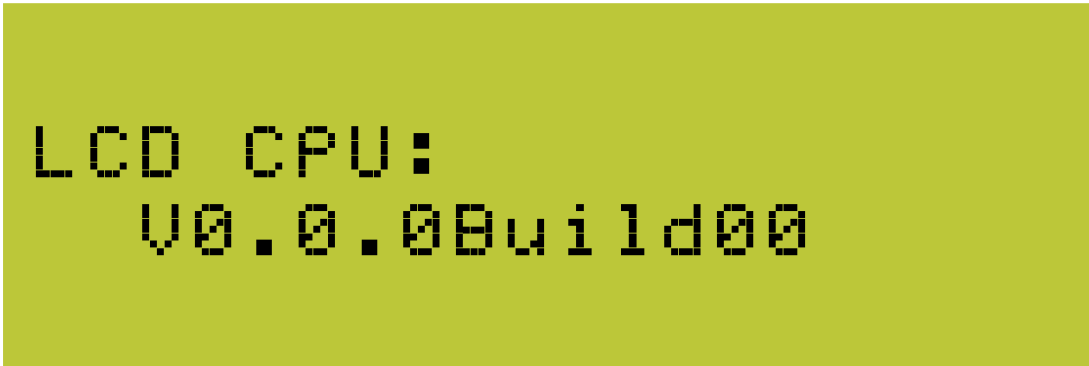

Error record display interface:

You can choose “**Error**” by **UP** and **DOWN** key in system operation interface 1

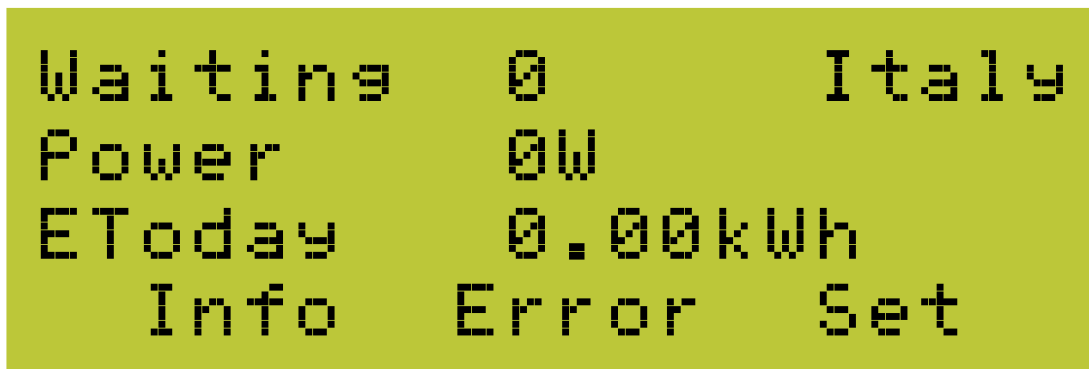

While “**Error**” flickers, confirm to enter the Error record mode.

Interface number of the Error record mode is unfixed; it ranges from 0 to 9 interfaces.

No error record interface:



Recent error record interface:

```

Page0      23-7-2013
E14        6-4-11
Master Grid Volt Fau
  
```

Earliest error record interface:

```

Page10     0 -0 -2000
E0         0 -0 -0
SCI Lose
  
```

Set mode:

You can choose “Set” by **UP** and **DOWN** key in system operation interface 1

```

Waiting    0      Italy
Power      0W
EToday     0.00kWh
Info      Error  Set
  
```

While “Set” flickers, confirm to enter the Set mode.

The Set mode is operated with 2 levels of menu. There are five items in the sub-menu, Time, Data, Password, Language and WiFi. The items are shown as following picture.

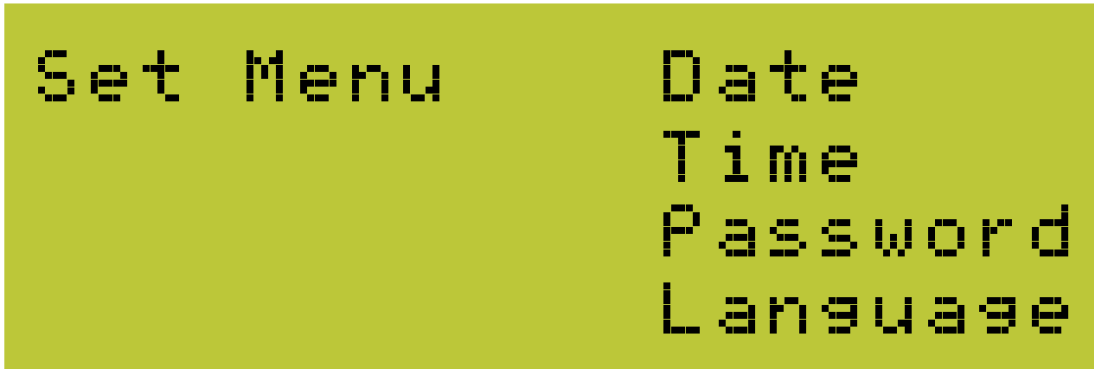

Choose the item which needs adjustment by **UP** and **DOWN** key in the sub-menu. The flickering one is the selected item.

Setting Language:

In the Set mode, choose Language by Up and Down key (as shown in the picture)

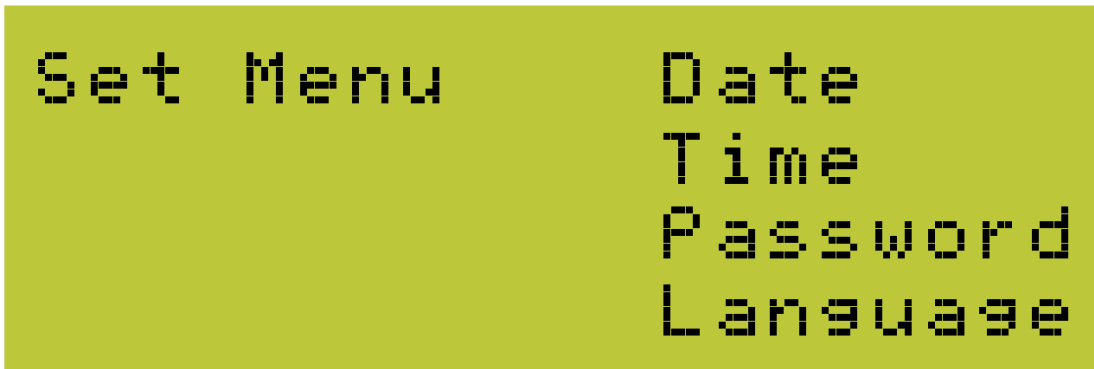

While "**Language**" flickers, confirm to enter the language option list.



Choose the target language, the corresponding language flickers. English, Dutch and Deutsch are available for displaying. Click **ENTER** to save data and back to prior menu.

Changing Password:

In the Set mode, choose "**Password**" by **UP** and **DOWN** key as shown in the picture.



```
Set Menu      Date
              Time
              Password
              Language
```

While “**Password**” flickers, confirm to enter the password modified interface.



```
Password
      000000
```

Input 6 figure passwords, check correctness and enter the modified mode



```
Password
      000000
```

Save password after the end of input

Back to two-level menu mode after saving the password

Setting Time:

In the Set mode, choose “**Time**” by **UP** and **DOWN** key as shown in the picture.

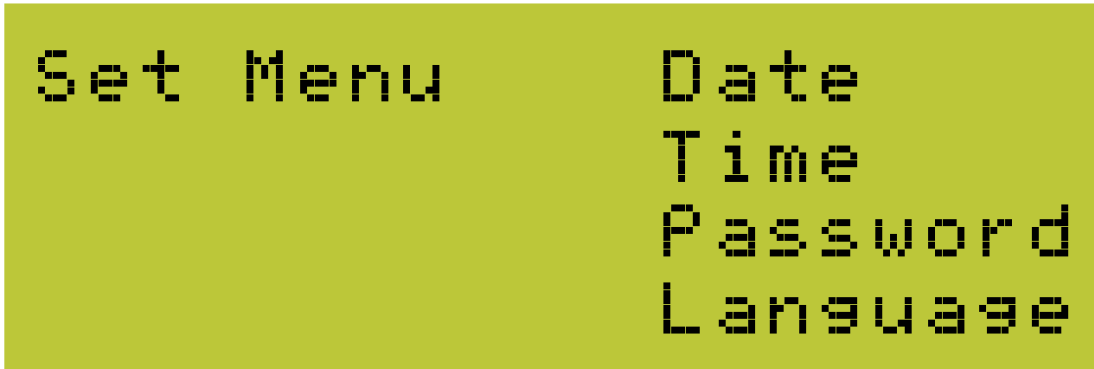

While “**Time**” flickers, confirm to enter the inverter time setting mode.

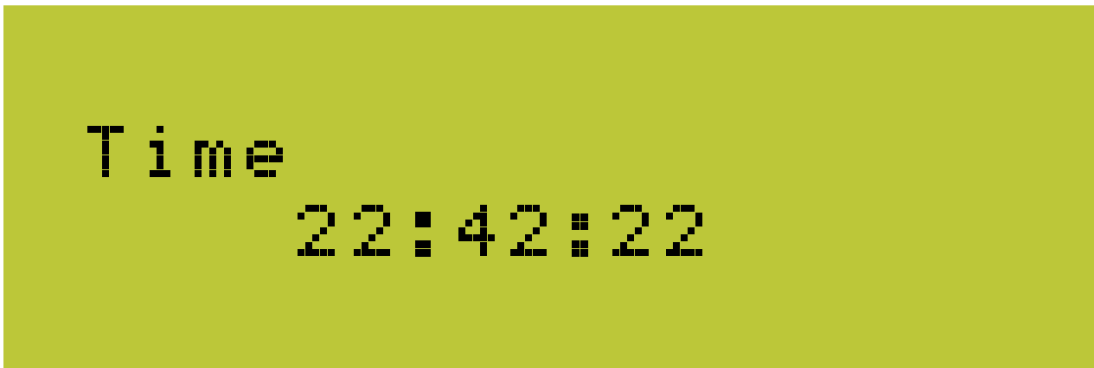

There are hour, minute and second displayed in the time setting mode. Use ENTER key to choose the one you want modify and **UP/DOWN** key to change the value.

Setting Date:

In the Set mode, choose “**Date**” by **UP** and **DOWN** key as shown in the picture.

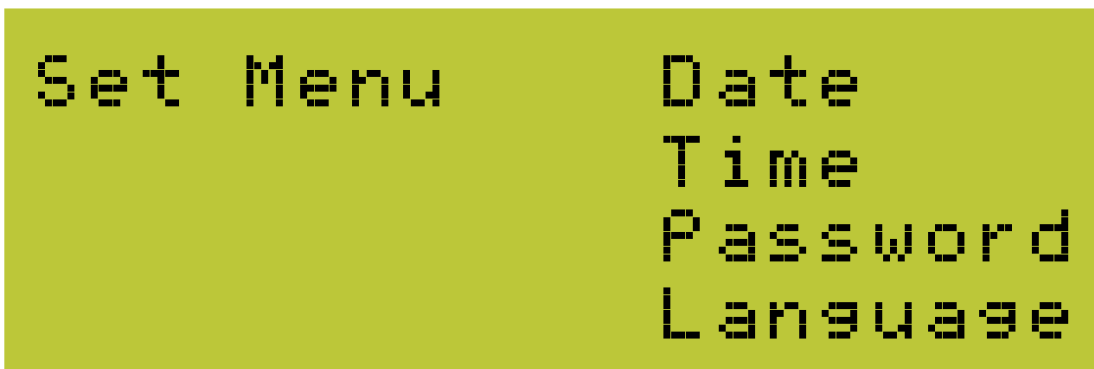

While “**Date**” field flickers, confirm to enter the inverter Date Setting mode

Date

23/07/2013

There are day, month and year displayed in the date setting mode, Set date by **Up/Down** key. Confirm to enter the next setting data, the sequence is day/month/year. After setting year, back to the two-level menu mode.

7.4 State Information

State	Display	State information
Wait	Waiting	Initialization & waiting
	Reconnects	Reconnect
	Checking's	Checking
Normal	Normal	Normal state
Fault	Current Fault	GFCI failure oversized leakage current
	Master Grid Freq Fault	Grid frequency failure
	Master Grid Freq Fault	Grid voltage failure
	PV Voltage Fault	Input voltage too high
	Over Temp Fault	Temperature abnormal
	Isolation Fault	Isolation failure
	Relay1 Fault Relay2 Fault	Output relay failure
	Current DC Offset	Output DC injection too high
	Eeprom Fault	EEPROM problem
	SCI Lose	Serial communication interface failure
	Hole Sense Device Fault	Output AC sensor abnormal
GFCI Failure	GFCI testing device abnormal	
Flash	F/W Updating	Update

About the further information for each fault, please reference to chapter “9.Troubleshooting”.

8. Recycling and Disposal

To comply with European Directive 2002/96/EC on waste Electrical and Electronic Equipment and its implementation as national law, electrical equipment that has reached the end of its life must be collected separately and returned to an approved recycling facility. Any device that you no longer required must be returned to your dealer or you must find an approved collection and recycling facility in your area.

Ignoring this EU Directive may have severe affects on the environment and your health.



WARNING



This device **SHALL NOT** be disposed of in residential waste.

9. Troubleshooting

	LCD display	Possible actions
Resumable Fault	Isolation Fault	<ol style="list-style-type: none"> 1. Check the impedance between PV (+) & PV (-) and the inverter is earthed. The impedance must be greater than 2MΩ. 2. Check whether the AC-side has contacts with earth.
	Current Fault	<ol style="list-style-type: none"> 1. The ground current is too high. 2. After cut off the AC side connection, unplug the inputs from the PV generator and check the peripheral AC system. 3. After the cause is cleared, re-plug the PV panel and AC connection, and check PV-Inverter status.
	Master Grid Freq Fault Master Grid Volt Fault	<ol style="list-style-type: none"> 1. Wait for a moment, if the grid returns to normal, PV-Inverter automatically restarts. 2. Make sure grid voltage and frequency meet the specifications.
	No Utility	<ol style="list-style-type: none"> 1. Grid is not connected. 2. Check grid connection cables. 3. Check grid usability. 4. If grid is ok, and the problem persists, maybe the fuse in the inverter is open, please call service.
	Over Temp Fault	<ol style="list-style-type: none"> 1. The internal temperature is higher than specified normal value. 2. Find a way to reduce the ambient temperature. 3. Or move the inverter to a cooler environment.
	PV Voltage Fault	<ol style="list-style-type: none"> 1. Check the open PV voltage; see if it is greater than or too close to 590VDC (for Omniksol-3k-TL2 or Omniksol-4k-TL2 or Omniksol-5k-TL2). 2. If PV voltage is less than 590VDC, and the problem still occurs, please call local service.
Permanent Fault	ENS Grid Voltage Fault ENS Grid Freq Fault	Disconnect PV (+) or PV (-) from the input, restart the inverter.
	Relay1 Fault Relay2 Fault	<ol style="list-style-type: none"> 1. Disconnect ALL PV (+) or PV (-). 2. Wait for a few seconds. 3. After the LCD switches off, reconnect and check again. 4. If the problems remain please call local service.
	Current DC Offset	
	Eeprom Fault	
	SCI Lose	
	Hole Sense Device Fault	
	GFCI Device Fault	

Error code list:

ERROR CODE	Description
0	GFCI Device Fault
1	Hole Sense Device Fault
2	Reference Device Fault
3	DCI ENS Fault
4	GFCI ENS Fault
5	Less Bus Low Voltage Fault
6	Over Bus High Voltage Fault
7	Master Device Fault
8	Master Delta Grid Z Fault
9	No Utility
10	Current Fault
11	Bus Voltage Fault
12	B12
13	Over Temp Fault
14	Auto Test fail
15	PV Voltage Fault
16	Fan Fault
17	Master Grid Volt Fault
18	Isolation Fault
19	Current DC Offset
20	ENS Grid VFZ Fault
21	ENS Grid Z Fault
22	ENS Grid Freq Fault
23	ENS Grid Voltage Fault
24	Relay2 Fault
25	Relay1 Fault
26	Slave Grid Z Fault
27	Master Grid Z Fault
28	Slave Grid Freq Fault
29	Master Grid Freq Fault
30	Eeprom Fault
31	SCI Lose

10. Abbreviation

LCD	Liquid Crystal Display
LED	Light Emitting Diode
MPPT	Maximum Power Point Tracking
PV	Photovoltaic
V _{dc}	Voltage at the DC side
V _{ac}	Voltage at the AC side
V _{mpp}	Voltage at the Maximum Power Point
I _{mpp}	Amperage at Maximum Power Point
AC	Alternating Current (Form of electricity supplied by Utility Company)
DC	Direct Current (Form of electricity generated by PV modules)
VDE 0126-1-1	German standard for establishing suitability for Grid Connection of the Inverter
VDE-AR-N 4105	German new standard for establishing suitability for Grid Connection of the Inverter. Including active and reactive power adjusting function
DC Switch	Switch in the DC Circuit. Disconnects DC source from Inverter. May be integrated or external to Inverter

11. Contact

Suzhou Headquarter

Xinghu Road No.218 bioBAY Park C2-101 215123 Suzhou China

Tel: +86 512 6295 6676

Fax: +86 512 6295 6682

Email: info@omnik-solar.com

www.omnik-solar.com

Omnik German Service Center

A der Pikardie 6

01277 Dresden

Deutschland

Tel: +49 (0)351 30986031

Fax: +49 (0)351 30930022

Email: service-de@omnik-solar.com

Service line

Tel: +86 512 6295 6676

Fax: +86 512 6295 6682

Email: service@omnik-solar.com